

Electronic MALL MADNESS[®]

Store Directory and Instructions

Attention Mall Shoppers!

Now you can shop till you drop as you rush from store to store! But before you start your shopping spree, you get to build your mall!

CONTENTS: *Electronic Speaker Unit, 6 Plastic Walls, 4 Shopping List Cards, 4 Credit Cards, 4 Playing Pieces, 42 Pegs, Gameboard, Mall Money, 3 Sign Stands, 2 Parts Sheets, Label Sheet*

Building Your Mall

1. Cardboard Parts: Carefully punch out the mall parts from the cardboard sheets. Remove and discard any waste cardboard remaining in the gameboard holes.

2. Speaker Unit: Apply 6 labels to the speaker unit as shown in Figure A. Then place the cardboard BANK and GAME ON pieces on top of the speaker unit as shown.

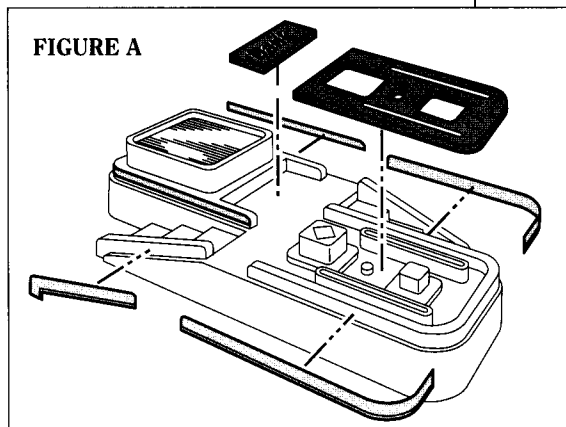

3. Battery Installation: Four "AA" size *alkaline* batteries are required, but not included.

Open the battery compartment cover located on the bottom of the speaker unit. See Figure B. Insert the batteries by matching the (+) and (-) signs. Then close the battery compartment cover.

Place the speaker unit in the center of the gameboard (as shown in figure D) by inserting the round "feet" on the base of the unit into the holes in the gameboard.

FIGURE B

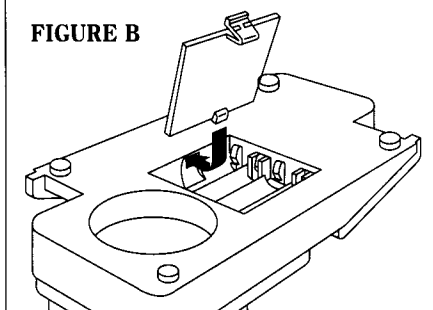

Test the batteries by pressing the GAME ON button. The Voice of the Mall should say, "Hi Red! Hi Blue! Hi Green! Hi Yellow!"

If you do not hear the voice, the batteries may be weak or improperly installed.

CAUTION: To Avoid Battery Leakage

- Be sure to insert the batteries correctly and always follow the toy and battery manufacturers' instructions.
- Do not mix old and new batteries or alkaline, standard (carbon-zinc) or rechargeable batteries.
- Always remove exhausted or dead batteries from the product.

IMPORTANT

GAME ON BUTTON:

Press the "GAME ON" button whenever you want to start a new game. Caution: If you accidentally press this button during a game, the computer's memory will be erased and the game will start over.

AUTOMATIC SHUTOFF:

If no buttons are pressed for 5 minutes, the Voice of the Mall will say, "Try again later" and the game will automatically shut off.

4. Mall Walls: Insert each of the 12 cardboard store fronts, 4 fountain pieces and 2 elevator pieces into the 6 mall walls as shown in Figure C. Use the black and tan illustrations on the gameboard as a guide for positioning each store front. Insert an elevator piece at both ends of the mall in the Department Store and the Fashion Boutique.

FIGURE C

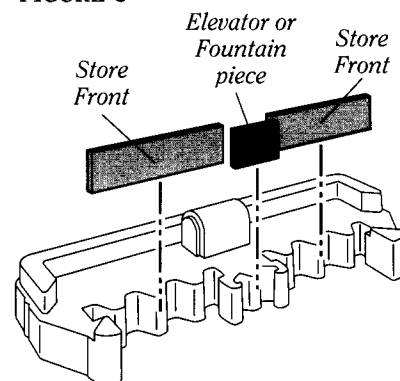



5. Gameboard: Place the 6 mall walls onto the gameboard as shown in Figure D.

6. Second Floor Pathway: Unfold the pathway and place it onto the mall as shown in Figure D below. Very gently bend or flex the walkway to lay it flat. See Figure D for the correct position of stores.

Note: Be sure to match the color of each corner pathway with the mall entrance color.

7. Entrance Arches: Insert the 4 arches into the slots of the mall walls as shown in Figure D.

8. Windows: Insert the 2 windows into the slots of the walls as shown in Figure D.

9. Signs: Insert the 2 Sale signs and 1 Clearance sign into the plastic stands as shown in Figure D.

Object of the Game

Be the first to buy 6 items on your shopping list and get back to the parking lot.

Setup

All players do the following:

- Choose one of the four color mall entrances and sit in front of it.
- Take a matching color Shopper piece and place it in the parking lot *outside* your entrance.
- Take a matching color shopping list card and credit card. Your shopping list card shows the location of each store in the mall. It also lists the item in each store that you can buy.

- Take 6 plastic pegs and insert them into your shopping list card as shown in Figure E.

- Choose a player to be the banker. The banker gives each shopper \$200 as follows: two \$50 bills, three \$20 bills, three \$10 bills and two \$5 bills. During the game, the banker collects all money from shoppers and gives out money as the Voice directs.

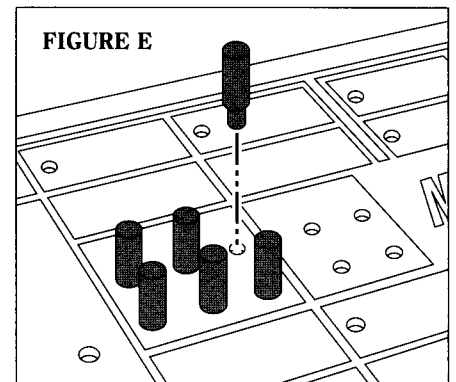
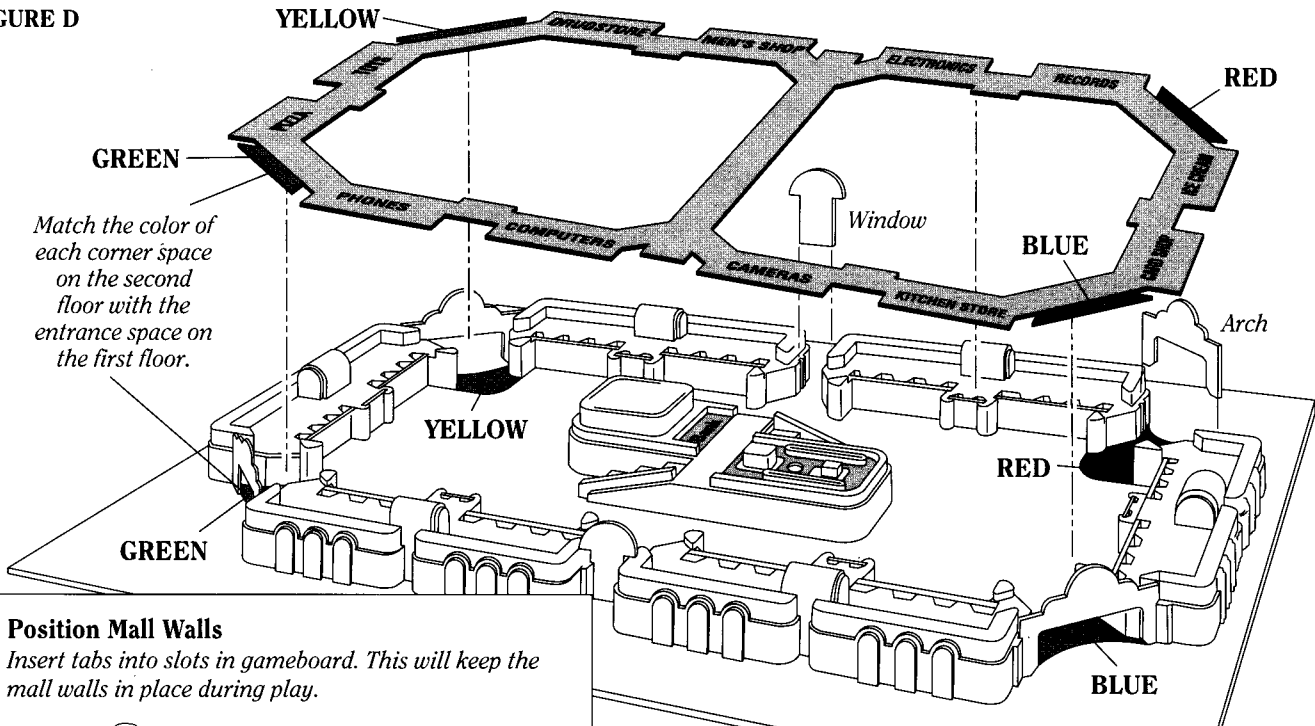

FIGURE E

FIGURE D



Match the color of each corner space on the second floor with the entrance space on the first floor.

Position Mall Walls

Insert tabs into slots in gameboard. This will keep the mall walls in place during play.

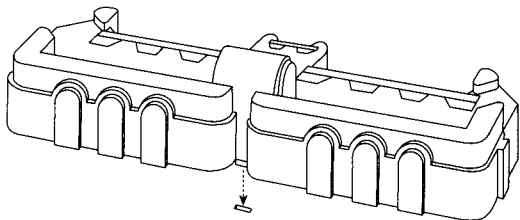

SIGNS





How to Play

Press the GAME ON button.

The Voice of the Mall will say, "Hi Red!...Hi Blue!...Hi Green!...Hi Yellow!" When you hear your color

 called, *immediately* press the Move button. This lets the computer know which shoppers are playing.

Example: You are the red shopper, Chris is the green shopper and Donna is the yellow shopper. As soon as you hear "Hi Red!," press the Move button. Next you will hear "Hi Blue!" Since no shopper is blue, no one presses the Move button. Chris presses the Move button immediately after hearing "Hi Green!" Donna presses the Move button as soon as she hears "Hi Yellow!"

The Voice will repeat each unselected color one more time — just in case a shopper forgot to press the button when his or her color was called. If you hear your color repeated, press the Move button.

The Shopping Begins

Position The Signs: After all shoppers have pressed the Move button, the Voice will say, "Attention Mall Shoppers!" It will then announce the store locations for one clearance and two sales. Shoppers should immediately place the clearance sign in the clearance store announced and the sales signs in the sales stores announced.

Note: During the game, new sales and clearances are announced every few minutes. Move the signs to the new locations as they are announced.

Turns Announced: The Voice then announces a shopper's turn by color. The shopper whose color is announced must move his or her Shopper piece as the Voice directs. Movement will be by number of spaces or to a specific location. See *Moving Through the Mall* section

below for details. After moving, the shopper presses the Move button to end his or her turn.

Play continues in a clockwise order with each shopper taking a turn as follows:

What to Do on Your Turn

1. Press the Move button to start your turn.
2. Listen to the Voice of the Mall.
3. Move your Shopper piece as directed. (Try to move into a store to buy or into the bank to get cash.)
4. Press the Move button to end your turn.

? Repeat Button: If you don't hear an announcement clearly, press the Repeat Button. The last announcement will be repeated.

Moving Through the Mall

There are two types of movement that the Voice could announce on your turn.

- Either move a certain number of spaces.
Example: "Red...Move Five."
- Or move to a specific location.
Example: "Red...Go to the Parking Lot."

Moving by Number of Spaces

Where to Move:

Try to move into a store to buy something. It's usually a good idea to head for a store that's having a sale or a clearance. You'll save cash and that means fewer trips to the bank!

How to Move:

- On your first turn, move from the parking lot to the Entrance space as shown in Figure F above. This counts as one space.

- Move from one adjacent space to the next. Each space counts as one.
- You can move forward or backward, left or right, but not diagonally. See Figure F.
- You don't have to move the full count announced when moving into a store or the bank.
- You can move over another Shopper piece and share a space with other Shopper pieces.
- You cannot move over store walls and you can only enter a store through its "door." See *Moving into a Store* section.

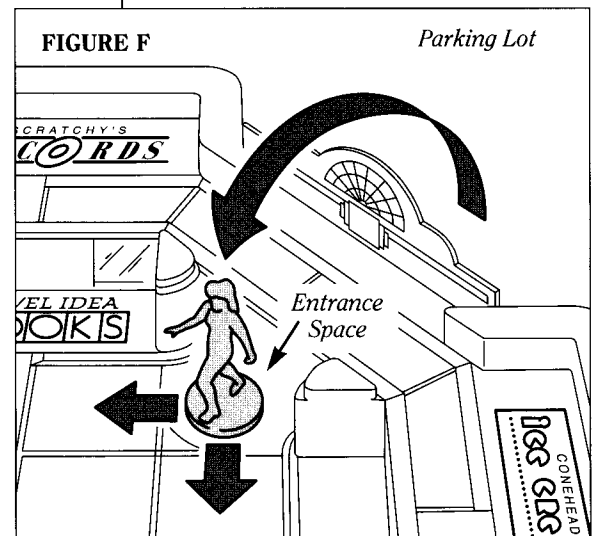



FIGURE G
MALL SPACES

- A. WALKWAY SPACE
- B. ELEVATOR SPACES
- C. ENTRANCE SPACE
- D. STORE SPACES
- E. BANK SPACE
- F. ESCALATOR SPACE
- G. FLOOR SPACE

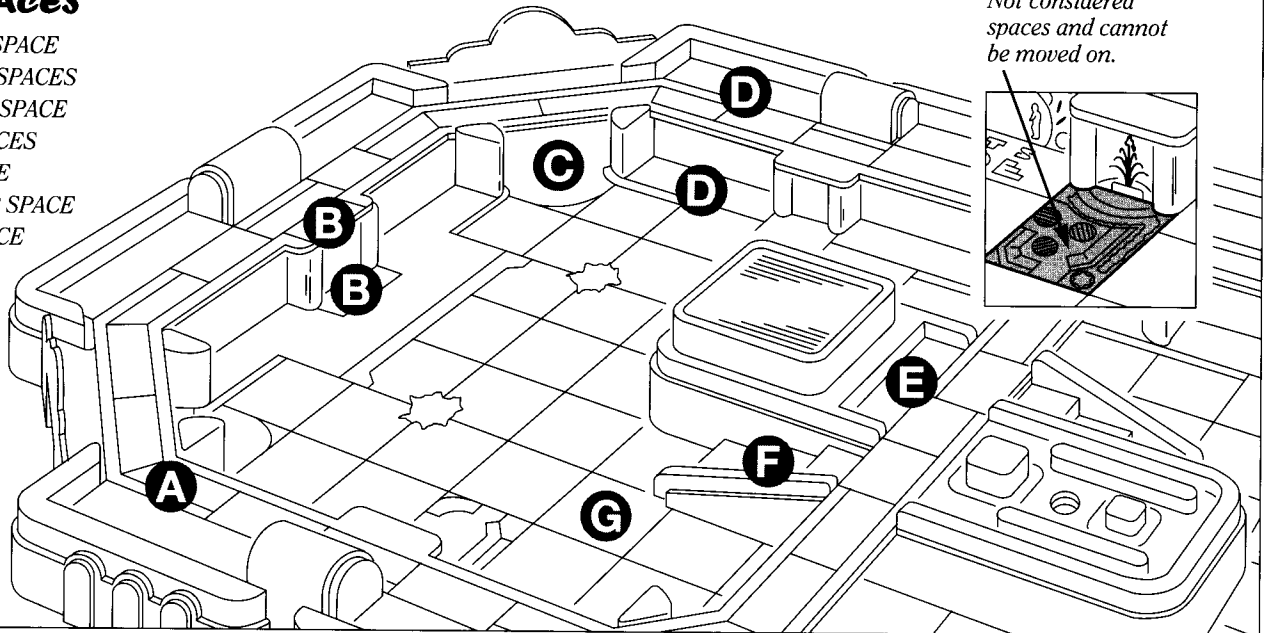
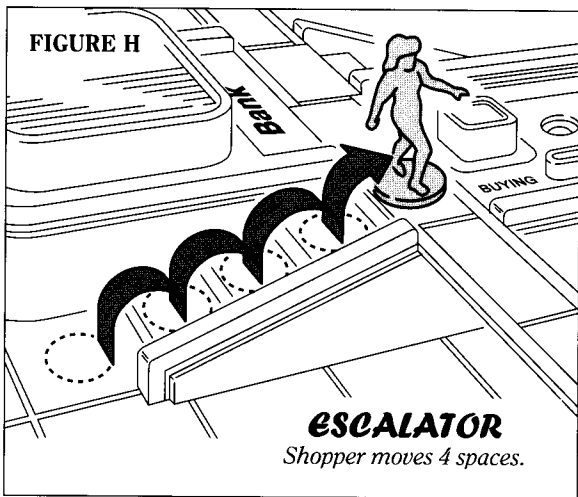

FIGURE H



Mall Spaces

There are many different types of mall spaces you can move onto. As you move through the mall, each of these spaces counts as one. See Figure G.

You can move from the first floor to the second floor and back by using the escalators in the center of the mall, or the elevators at either end of the mall. See Figures G, H and I.

FIGURE I

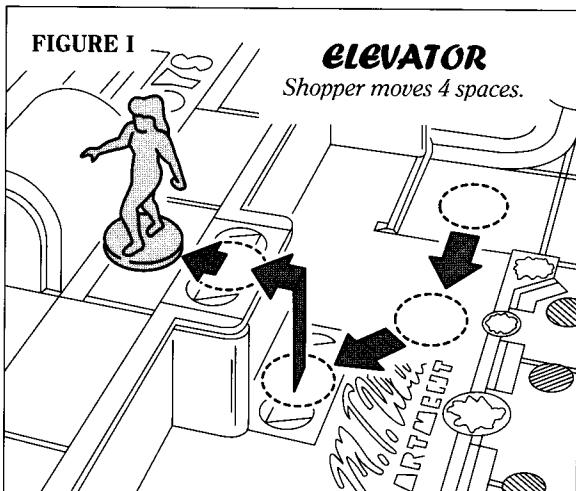

Moving to a Specific Location

On your turn, if you hear any of the following announcements, move your Shopper piece to the announced location.

What you hear: "Meet All Shoppers at the Bank."

What you do: You and all other shoppers must immediately move your Shopper pieces to the bank space. All shoppers (starting with you) take turns in clockwise

order inserting their credit cards into the bank slot. The Voice will announce how much money each shopper gets. The banker gives each shopper the appropriate amount. After all shoppers have received their cash, press the Move button to end your turn.

What you hear: "You're Hungry. Meet a Friend at the Pizza Shop."

What you do: Move your Shopper piece and any opponent's Shopper piece to the Pizza Shop. Press the Move button to end your turn. (To buy a pizza, see *Special Situations* on page 6.)

What you hear: "Move (number of spaces) and Send a Friend to the Arcade." or "Move (number of spaces) and Send a Friend for Ice Cream." or "Move (number of spaces) and Send a Friend Anywhere."

What you do: Move your Shopper piece as directed. Then move any opponent's Shopper piece to the announced space. If you send an opponent to a store or the bank,

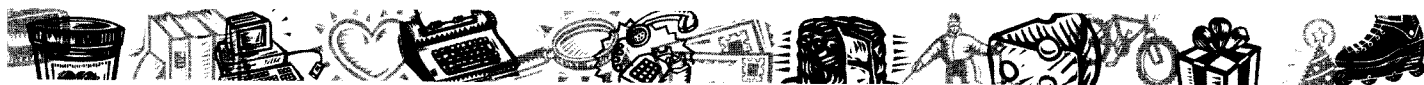

he or she cannot buy or bank on your turn. Press the Move button to end your turn.

What you hear: "Go to the Restroom."

What you do: Move your Shopper piece to the restroom space. Then press the Move button to end your turn.

What you hear: "You Left Your Lights On, Go to the Parking Lot."

What you do: Move your Shopper piece back to your parking lot. Then press the Move button to end your turn.

Moving into a Store

You must enter a store through its "door." See Figure J. Move into a store only when you want to buy an item in it. You don't have to move the full count announced when moving into a store. Once you move into a store and buy an item, you cannot visit that store again (except the Pizza Shop — see *Special Situations* on the next page).

Remember, to save money, it's usually a good idea to head for a store that's having a sale or clearance.

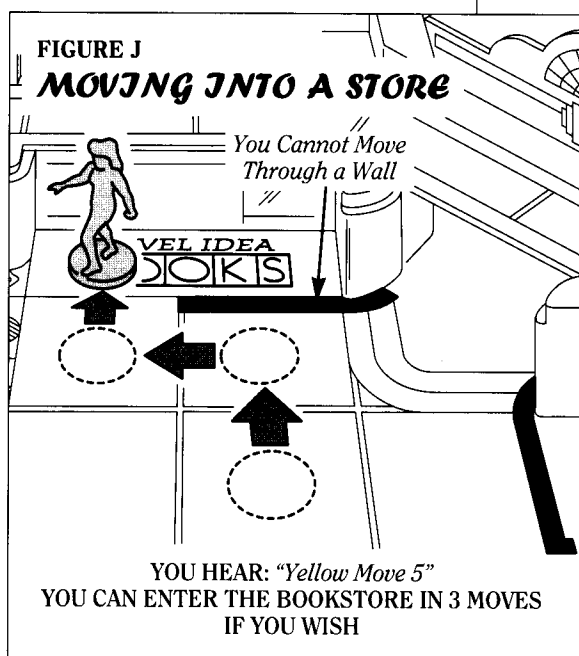

But hurry! Sales and clearances change every few minutes. You may arrive too late to get the bargain.

Of course, you are free to shop in *any* store — and if you're lucky, a surprise sale or clearance may be announced!

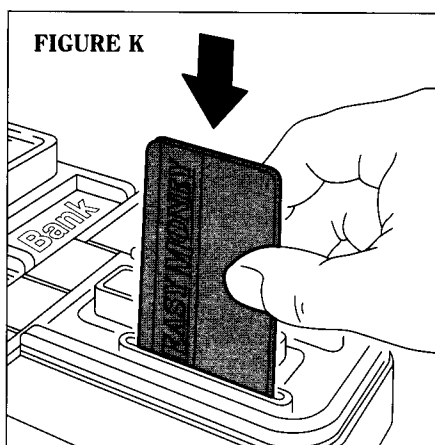

Buying an Item

Once you move into a store, put your credit card into the buy slot. See Figure K. You will hear one of the following announcements:

What you hear: "Ching Ching!"

What you do: This is the sound of the cash register ringing up your purchase. You've made a successful buy. Look at your shopping list card for the cost of the item and pay the appropriate amount to the bank.

- Pay REGULAR price if there are no sale or clearance signs in the store.
- Pay SALE price if there is a sale sign in the store.
- Pay CLEARANCE price if there is a clearance sign in the store.

Put a peg into your shopping list card next to the item you purchased. Then press the Move button to end your turn.

What you hear: "Hey! You Get a Special Sale!" or "Hey! You Get a Special Clearance!"

What you do: Surprise! Pay the bank the announced discount price as shown on your shopping list card. Put a peg in your shopping list card next to the item you purchased. Then press the Move button to end your turn.

Note: If you are in a store with a clearance sign and the Voice says there is a *special sale*, you have to pay the sale price shown on your card. If you are in a store with a *sale* sign and the Voice says there is a *special clearance*, you pay the lower clearance price. **The Voice of the Mall always has the final word!**

What you hear: "Long Line, Try Again Later!" or "I'm Sorry, We're Out of Stock, Try Again Later!"

What you do: You can't buy anything now. Press the Move button to end your turn.

On your next turn (as long as you aren't told to move elsewhere), you can try to buy again. Here's how:

Press the Move button as usual and do one of the following:

- If you are told to move a certain number of spaces, simply move out of the store and right back in again. Then insert your credit card into the buy slot. Good Luck!
- If you are told to move to a specific location, you must leave the store and go to that location. Sorry!

What you hear: "Your Item Costs \$5 More!"

What you do: Whatever you would have paid, add \$5 and pay the higher amount. (You never know when this announcement will come up, so it's a good idea to have an extra \$5 on hand in case you need it.)



Going to the Bank

After buying a few items, you will have to go to the bank to get more money. You don't have to move the full count announced when moving into the bank. When you move onto the bank space, insert your credit card into the bank slot. The Voice will tell you to take \$50, \$75, or \$100 from the bank, or you will be told that the bank is closed.

Once you get money from the bank, you can't go back to the bank until you buy something. If you stop at the bank without buying something first, the Voice will say, "Bank closed."

Exception: If the Voice says, "Meet All Shoppers at the Bank," then everyone is allowed to withdraw money, even if they already went to the bank (and haven't bought anything since then).

Special Situations

Buying a Pizza — Here's a quick way to get cash! If you can't go to the bank (because you haven't bought anything since your last bank visit), then go to the Pizza shop and try to buy a pizza for only \$5. It's a cheap purchase that frees you up to return to the bank!

Just insert your credit card in the buy slot as you would with any other purchase. The Voice will tell you whether you've made a successful purchase. You do *not* get a peg for buying pizza, but now you can head for the bank on your next turn to get more cash. Note: Pizza is never less than \$5 but sometimes it costs \$5 more! You can return to the Pizza shop as often as you wish.

Changing Your Mind — If you hit the Move button to end your turn and then realize that you wanted to bank or buy, go ahead and use your credit card. The Voice of the Mall will know that it is still your turn. After banking or buying, be sure to hit the Move button to end your turn.

Note: If you hit the Move button to *end* your turn and the next player hits the Move button to *start* his or her turn, it is too late for you to do anything.

Cancel a "Buy" — Occasionally, you may use your credit card and then discover that you do not have enough money to buy an item (or realize that you already bought the item in that store). If this happens, the bank will think that you actually did buy something — and may allow you to withdraw cash if you return to the bank. This is not fair to the other players, so you must cancel your "buy." Insert your credit card into the buy slot *again* and you will hear "Try again later." This sets things right in the computer. Press the Move button to end your turn.

Card Slot Errors — If you put your credit card into the wrong slot, simply remove it and insert it into the correct slot. The computer will automatically correct the error.

Winning the Game

Be the first player to buy 6 different items and get back to your parking lot.

Shop Till You Drop

For a longer shopping spree, insert 10 pegs into your shopping list card and try to buy 10 different store items.

FCC Statement

This equipment generates, uses, and can radiate radio frequency energy and, if not installed and used in accordance with the instructions, may cause harmful interference to television or radio reception. It has been tested and found to comply with the limits for a Class B digital device, pursuant to Part 15 of the FCC Rules. These limits are designed to provide reasonable protection against harmful interference in a residential installation. However, there is no guarantee that interference will not occur in a particular installation. If this game does cause

harmful interference to radio or television reception, which can be determined by turning the equipment off or on, the user is encouraged to try to correct the interference by one or more of the following measures:

- Reorient or relocate the receiving antenna.
- Increase the separation between the equipment and the receiver.
- Connect the equipment into an outlet or circuit different from that to which the receiver is connected.
- Consult the dealer or an experienced radio/TV technician for help.

Warning: Changes or modifications to this unit not expressly approved by the party responsible for compliance could void the user's authority to operate the equipment.

Store Name Credits

NOVEL IDEA BOOKS is a trademark of and used with permission by Annie's Book Stop.

HOCUS-FOCUS is a trademark of and used with permission by Byron Booth & Associates.

Milton Bradley Company
P.O. Box 1247
East Longmeadow, MA 01028

© 1990, 1996 Milton Bradley Company.
All Rights Reserved. 4047-XI

